



REVOLUTION™ HYDROSTEAM™
UPRIGHT CARPET CLEANER WITH STEAM
 MODELS 3672E, 3670E

What's in the Box?.....	3	Cleaning with the Hose and Tools.....	7
Assembly	3	After-Cleaning Care	8
Controls and Cleaning Modes.....	3	Replacing Belts and Brush Rolls.....	11
Filling the Clean Water Tank.....	4	Troubleshooting.....	11
Three Modes of Cleaning.....	5	Limited Warranty	12



Product Overview

1. Handle with Fingertip Controls
2. Clean Water Tank Handle
3. Clean Water Tank
4. Dirty Water Tank Handle
5. Machine Handle
6. Dirty Water Tank
7. Mode Indicator Lights
8. Accessory Door
9. HydroSteam Bar
10. EdgeSweep® Brushes
11. Formula & Steam Spray Trigger
12. Quick Release™ Cord Wrap
13. Recline Pedal

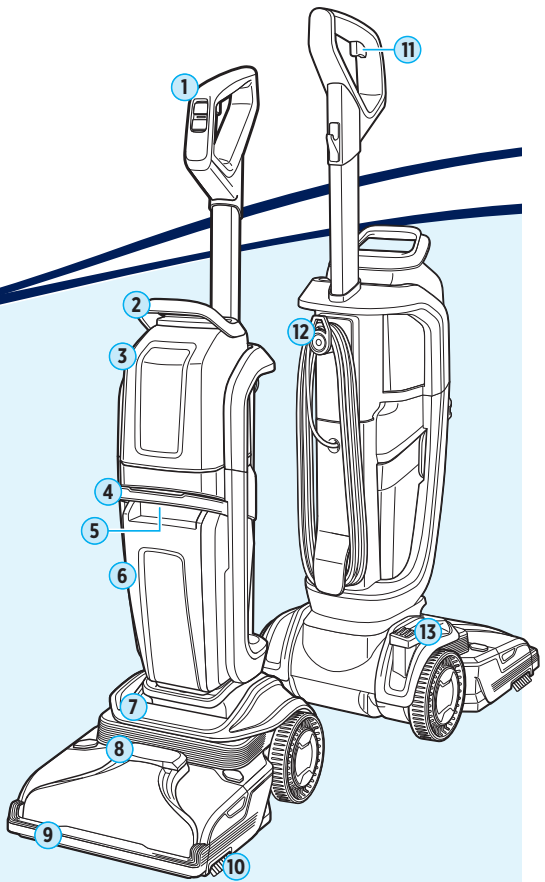

SYMBOL	EXPLANATION
	Caution.
	Read operator's manual.
	Risk of fire.
	Risk of electric shock.
	Do not expose to rain.
	Store indoors.
	Do not overwet carpet. Use only on carpet moistened by the cleaning process.

SYMBOL	EXPLANATION
	Disconnect power before servicing.
	Do not freeze.
	Lock.
	Protection against moving parts.
	Risk of automatic start-up.
	Use warm water, temperature up to 60°C.

SYMBOL	EXPLANATION
	Use only BISSELL® cleaning formulas intended for use with this machine.
	Check the manufacturer's tag before cleaning textile. "W" on the tag as shown means you can use your cleaner.
	This symbol on the product and/or accompanying documents means that used electrical and electronic products should not be mixed with general household waste. For proper treatment, recovery and recycling, please take this product to designated collection points. Please contact your local authority for further details of your nearest designated collection point.

IMPORTANT SAFETY INSTRUCTIONS

READ ALL INSTRUCTIONS BEFORE USING YOUR APPLIANCE.

When using an electrical appliance, basic precautions should be observed, including the following:

WARNING TO REDUCE THE RISK OF FIRE, ELECTRIC SHOCK OR INJURY:

- This appliance can be used by children aged from 8 years and above and persons with reduced physical, sensory or mental capabilities or lack of experience and knowledge if they have been given supervision or instruction concerning use of the appliance in a safe way and understand the hazards involved. Cleaning and user maintenance shall not be made by children without supervision.
- Children should be supervised to ensure that they do not play with the appliance.
- Unplug from electrical socket when not in use, before cleaning, maintaining, or servicing the appliance, and if your appliance has an accessory tool with a moving brush, before connecting or disconnecting the tool.
- Do not immerse in water or liquid.
- Keep hair, loose clothing, fingers, and all parts of body away from openings and moving parts of the appliance and its accessories.
- Use only BISSELL® cleaning products intended for use with this machine.
- Use only the type and amount of liquids specified under the operations section of this guide.
- Use only on carpet moistened by the cleaning process.
- If the supply cable is damaged, it must be replaced by the manufacturer, its service agent or similarly qualified person in order to avoid a hazard.

- Do not use with damaged cable or plug.
- Do not pull or carry by cable, use cable as a handle, close door on cable, or pull cable around sharp edges or corners.
- Keep cable away from heated surfaces.
- Do not immerse in water for cleaning.
- Use only the type and amount of liquids specified under the operations section of this guide.
- Keep out of reach of children when it is energized or cooling down.
- Do not direct steam at people, animals or equipment containing electrical components.
- Always connect to a properly earthed electrical socket. Do not modify earthed plug.
- The appliance is not to be used if it has been dropped, if there are visible signs of damage or if it is leaking.
- The foot surfaces are liable to get hot during use.
- Do not use on leather, wax polished furniture or floors, synthetic fabrics, velvet, or other delicate, steam-sensitive materials.
- Always turn OFF vacuum mode if you encounter liquid on the floor.
- Do not open the filling aperture during use.
- To unplug, grasp the plug, not the cable.
- Do not handle plug or appliance with wet hands.
- Plastic film can be dangerous. To avoid danger of suffocation, keep away from children.
- Use only as described in this user guide.
- Use only manufacturer's recommended attachments.

- If appliance is not working as it should, has been dropped, damaged, left outdoors, or dropped into water; do not attempt to operate it and have it repaired at an authorized service center.
- Do not put any object into openings.
- Do not use with any opening blocked; keep free of dust, lint, hair, and anything that may reduce air flow.
- Use extra care when cleaning on stairs.
- Do not use to pick up flammable or combustible liquids, such as petroleum, or use in areas where they may be present.
- Do not pick up toxic material (chlorine bleach, ammonia, drain cleaner, etc.).
- Do not use appliance in an enclosed space filled with vapors given off by oil-based paint, paint thinner, some moth-proofing substances, flammable dust, or other explosive or toxic vapors.
- Use indoors only.
- Do not pick up anything that is burning or smoking, such as cigarettes, matches or hot ashes.
- If your appliance is fitted with a nonrewireable BS 1363 plug it must not be used unless a 13 amp (ASTA approved to BS 1362) fuse is fitted in the carrier contained in the plug. Spares may be obtained from your BISSELL® supplier. If for any reason the plug is cut off, it must be disposed of, as it is an electric shock hazard should it be inserted into a 13 amp socket.

SAVE THESE INSTRUCTIONS

ORIGINAL INSTRUCTIONS.

FOR OPERATION ON A 220-240 VOLT A.C. 50-60 HZ POWER SUPPLY ONLY.







THIS MODEL IS FOR HOUSEHOLD USE ONLY.

IMPORTANT INFORMATION

- Keep appliance on a level surface.
- To reduce the risk of a leaking condition, do not store unit where freezing may occur. Damage to internal components may result.

What's in the Box?

Standard accessories may vary by model. To identify what should be included with your purchase, please refer to the "Carton Contents" list located on the carton top flap.

					
Upper Body and Clean Water Tank	Lower Body with Dirty Water Tank	Handle	Hose & Tool Bag	Tools (vary by model)	Trial Formula

Assembly

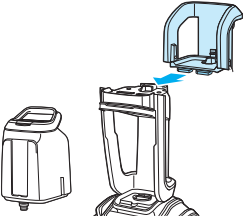
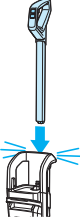
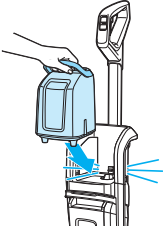

		
<p>1. Remove clean tank from upper body. Ensure upper body is level with lower body. Tip machine forward and slide the upper body into the lower body from the back as shown.</p>	<p>2. Insert handle into machine until it clicks into place.</p>	<p>3. Insert clean tank into machine until it clicks into place.</p>

Controls and Cleaning Modes

Fingertip Controls



Mode

Switch between Steam Pretreat, SteamWash Max Clean, and Quick Dry modes. Mode selection appears on the foot display.



Power

Turn the machine ON and OFF.

Foot Display & Cleaning Modes



Steam Pretreat Mode

Loosen tough stains before removing with SteamWash Max Clean mode.



SteamWash™ Max Clean Mode

Use water, formula and steam to clean your carpet.



Quick Dry Mode

Use water and formula for a quick clean. Carpets will dry in about 30 minutes.

Filling the Clean Water Tank



This machine is compatible with BISSELL® formulas made for upright carpet cleaners. Always use genuine BISSELL formulas in your machine. Other formulas may harm the machine.

Note: Fill with warm (60°C MAX) tap water and add the appropriate BISSELL® formula. Do not use boiling water. Do not heat water or tank in microwave.



Pretreat spots and stains to improve carpet cleaning performance.



Keep plenty of BISSELL cleaning formulas on hand so you can clean whenever it fits your schedule.



Add Boost carpet cleaning formula enhancers to any formula to increase its effectiveness.

<p>1. Choose your formula. Visit global.BISSELL.com.</p>	<p>2. Lift tank to remove from machine. Flip open lid.</p>	<p>3. Choose large or small area fill lines to suit your needs.</p>
<p>4. Add warm tap water (140°F/60°C max) to water fill line. Do not use boiling water. Do not heat water in microwave.</p>	<p>5. Add BISSELL formula to formula fill line.</p>	<p>6. Close lid until it clicks. Reinstall clean tank. It will click into place.</p>

***Compatible formulas include:**

3672E: Wash & Protect Pro.

3670E: Wash & Protect Pro Stain & Odour, Wash & Protect Pet Stain & Odour, Wash & Protect Stain & Odour, Stain Pretreat, Pet Stain Pretreat, Oxy Boost, Natural Carpet Deep Cleaning Solution, Natural Pet Carpet Deep Cleaning Solution.

⚠ WARNING To reduce the risk of fire and electric shock due to internal component damage, use only BISSELL cleaning formula intended for use with this machine.

Three Modes of Cleaning

Startup

- This appliance is primarily a carpet cleaner with a steam-cleaning feature.
- Remove any solids and use a dry vacuum cleaner over area before using your deep cleaner.
- To prevent damage to Berber-style carpets, avoid repeated strokes in the same area. Before cleaning area rugs, check the manufacturer's tag and test an inconspicuous spot on the rug for colorfastness. **Do not use on silk or delicate rugs.**
- Stay off carpet until dry.

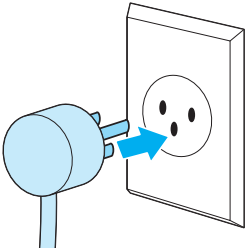
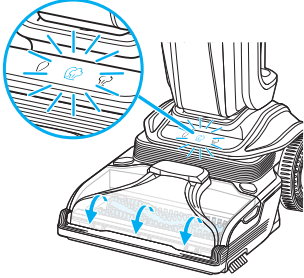
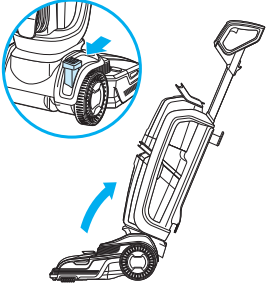
		
<p>1. Plug into a properly grounded outlet. Press power button on handle to turn ON.</p>	<p>2. Water heater will turn on. Machine defaults to SteamWash Max mode with brush rolls and vacuum motor on. Icon on foot will blink then turn solid when heater is ready to make steam (<60 seconds).</p>	<p>3. Press recline pedal to recline machine.</p>

Steam Pretreat Mode

Loosen tough stains before removing with SteamWash Max Clean mode. **Brush rolls and vacuum motor will shut off** in this mode.

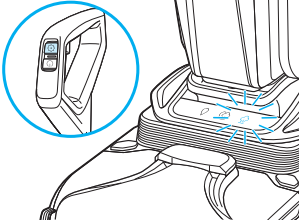
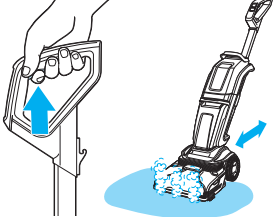
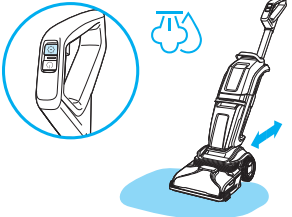

		
<p>1. Press mode button until Steam Pretreat icon is illuminated. Icon will blink until heater is ready to make steam.</p>	<p>2. Press recline pedal to recline machine. Pull trigger to release steam and move machine forward and back over stain for 20 seconds.</p>	<p>3. After steam pretreat, press mode button to clean the stain in SteamWash Max mode.</p>

CONTINUED ON NEXT PAGE 

Three Modes of Cleaning (continued)

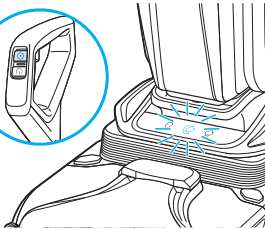
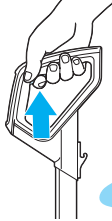
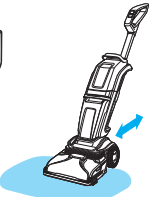
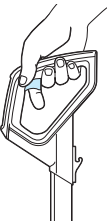

SteamWash™ Max Clean Mode

Use water, formula, and steam to clean your carpet. **Steam is present but not visible in this mode.** Carpets will dry in about 8 hours.

 	 	 
<p>1. Press mode button until SteamWash Max Clean icon illuminates on foot. When ready, indicator light will stay illuminated.</p>	<p>2. Press recline pedal to recline machine. Pull trigger to dispense water, formula, and steam. While holding trigger, make two “wet passes,” moving machine forward and back across carpet.</p>	<p>3. Release trigger and make “dry passes” by pushing machine forward and back, at least two times, across carpet or until water can no longer be seen in nozzle.</p>

Quick Dry Mode

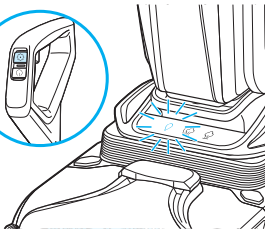
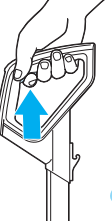
Water and formula for a quick clean. Carpets will dry in about 30 minutes.

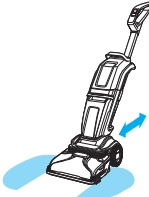
 	 	 
<p>1. Press mode button until Quick Dry icon illuminates on foot.</p>	<p>2. Press recline pedal to recline machine. Pull trigger to dispense water and formula. While holding trigger, make two “wet passes,” moving the machine forward and back across carpet.</p>	<p>3. Release trigger and make “dry passes” by pushing machine forward and back, at least two times, across carpet or until water can no longer be seen in nozzle.</p>

Cleaning with the Hose and Tools

Tools vary by model.



Note: Only water and formula flows through hose and tool, not steam.

Attaching the Hose

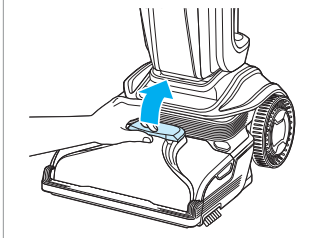

1. Lift accessory hose door on top of foot on the front of machine. Flip door toward machine to open.

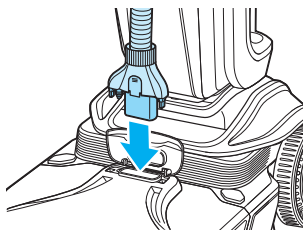

2. Insert hose until it clicks into place. Be sure colored hose release clip is facing out, away from machine.

Attach tool to end of hose.

8cm and 15cm Tool

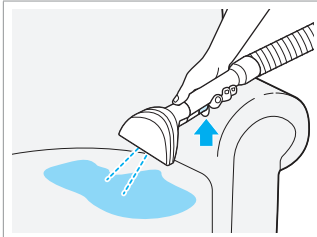

1. Point tool above spot or stain and press spray trigger.

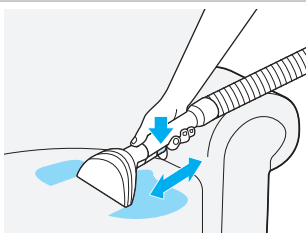

2. Release spray trigger and gently scrub the stain.

3-in-1 Stair Tool

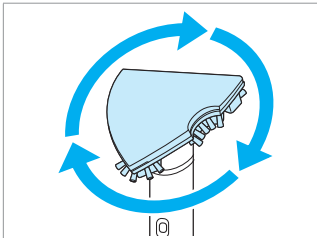

1. Twist tool to desired position. The downward facing edge is the active cleaning mode.

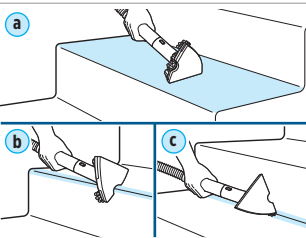

2. Use to clean stairs three ways:
a. Flat edge: stair tread
b. Indented area: outer corner
c. Pointed edge: inner corner

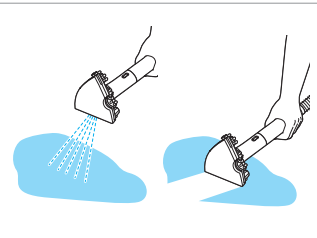

3. Point tool about 2 cm above stain and press trigger. Suction stain by placing tool on surface and slowly moving backwards.



After-Cleaning Care

For more helpful maintenance tips, check out global.BISSELL.com.

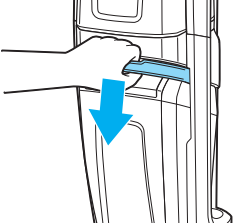

Emptying the Dirty Water Tank

Note: When the tank is full, the float will shut off suction and emit a high-pitched sound indicating it is time to empty your tank.

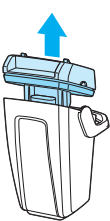
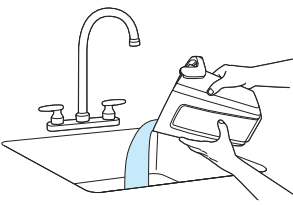
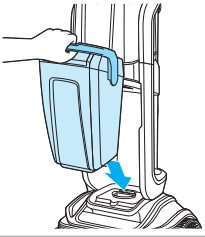
		
<p>1. To release dirty water tank, press down on tank handle and tilt tank toward you.</p>	<p>2. Remove tank and carry to disposal area.</p>	<p>3. Unlock by rotating handle back.</p>
		
<p>4. Grab lid in recessed area on both sides and pull up to remove.</p>	<p>5. Empty dirty water into utility sink. Reinstall lid and rotate handle forward to lock in place.</p>	<p>6. Reinstall tank. Insert bottom first. Then, tilt tank toward machine and push top in until it clicks into place.</p>

Cleaning the Machine

Nozzle may be HOT. Let machine cool before touching.

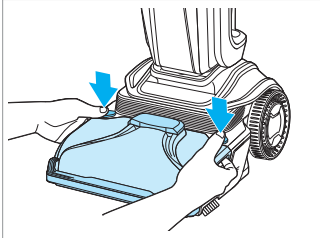

1. Place fingertips into grips on both sides of nozzle. Press release buttons with thumbs and rotate nozzle to remove.

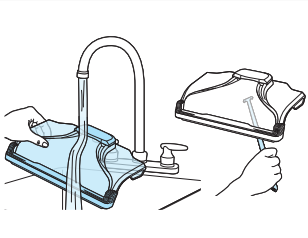

2. Open hose door. Rinse nozzle with warm water. Remove debris with clean out tool. **Note:** Parts are not dishwasher or automatic washing machine safe.

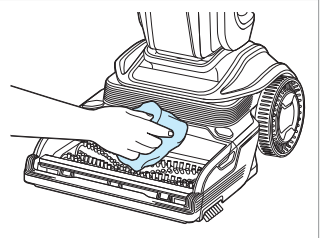

3. If brush roll chamber is dirty, clean with a cloth.

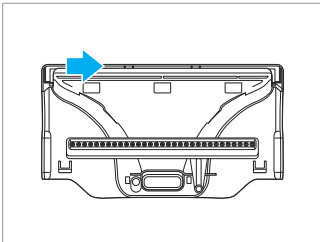

4. Check steam bar for clogs. Wipe underside of steam bar with a wet towel or manually remove visible clogs if necessary.

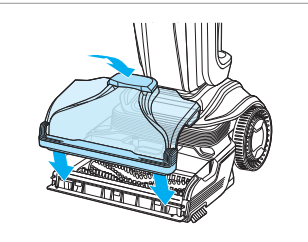

5. Let nozzle dry before reassembling. Reinstall nozzle by first lining up tabs with grooves of foot. Rotate nozzle back into place until you feel two clicks.

CONTINUED ON NEXT PAGE ➔

⚠ WARNING To reduce the risk of injury, do not touch the steam cleaning nozzle or adjacent surfaces when steam-cleaning or when the nozzle is heated.

Using the Rinse and Storage Tray (varies by model)

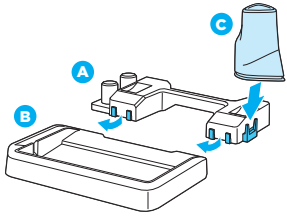
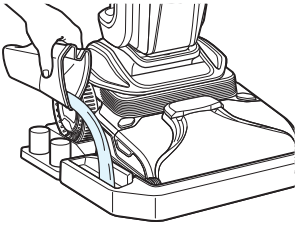
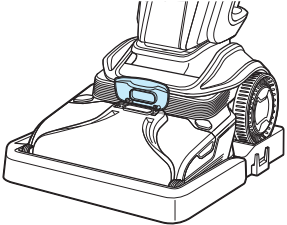
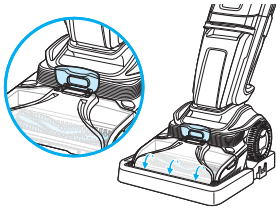
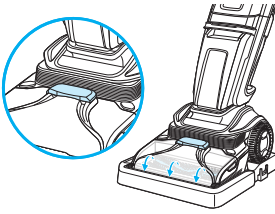
		
<p>1. There are 2 hooks on each side of part A that hook under part B. Press B down onto A. The water cup (C) can be stored on the side of the tray.</p>	<p>2. Place machine on tray. Fill rinse cup with fresh tap water to the fill line printed on cup. Pour water into tray as shown.</p>	<p>3. Open hose door on foot.</p>
		
<p>4. With hose tool door open, recline machine and press power button to turn ON. Run for 6-8 seconds to rinse brush rolls.</p>	<p>5. Close hose tool door. Press power button to turn ON and run until all water is picked up. Repeat steps 3-4 until foam is completely rinsed. Press power button to turn machine OFF.</p>	

Storing Your Machine

Once your cleaning is complete, make sure both the dirty and clean water tanks are emptied, rinsed out, and dried before the next use. Wrap cord around cord wrap for storage. Store machine in a protected, dry area.

Replacing Belts and Brush Rolls

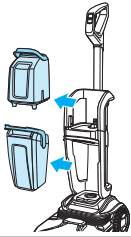

1. Unplug machine and remove both tanks. While reclined, lay machine on its front.

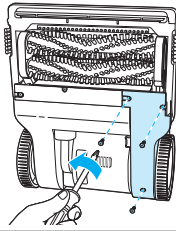

2. Remove belt cover. Use Phillips-head screwdriver to remove three screws.

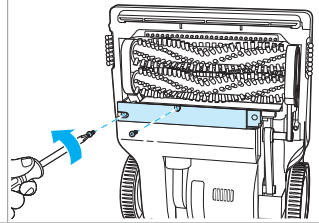

3. Use Phillips-head screwdriver to remove two screws. Then remove brush roll assembly by unhooking belt.

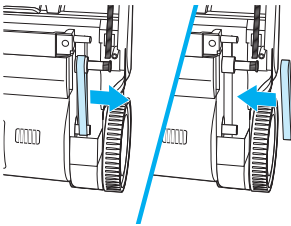

4. If flat belt is broken, place a new belt around red pulley. Stretch belt toward back of machine and around metal shaft.

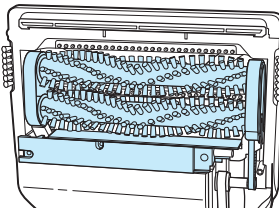

5. If brush roll belts or brush roll assembly is broken, replace with new brush roll assembly.

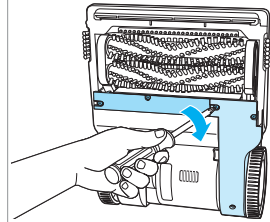

6. Reinstall brush roll assembly, making sure to loop belt over the shaft. Reinstall belt cover.

Troubleshooting

For a comprehensive walkthrough of your product and support tips visit global.BISSELL.com.

Note: Any other servicing should be performed by an authorised service representative.

⚠ WARNING To reduce the risk of injury, do not touch the steam cleaning nozzle or adjacent surfaces when steam-cleaning or when the nozzle is heated.

Limited Warranty

This limited warranty only applies outside of the USA, Canada, Australia, New Zealand, and mainland China. It is provided by BISSELL International Trading Company B.V. ("BISSELL") and gives you specific rights. It is offered as an additional benefit to your other rights under your local laws, which may vary from country to country. You can find out about your legal rights and remedies by contacting your local consumer advice service. Nothing in this warranty will replace or lessen any of your legal rights or remedies. If you need additional instruction regarding this warranty or have questions regarding what it may cover, please contact BISSELL Consumer Care or contact your local distributor.

This warranty is given to the current owner of the product with the original sales receipt. The original sales receipt must include the product(s) purchased, the date purchased, and which country it was purchased from new. You must be able to evidence the date of purchase and the country where the product was purchased to submit a claim under this warranty. You will receive the warranty that is applicable to the country where your product was originally purchased, as shown on the original sales receipt. If you use the product outside of the country where it was purchased, your warranty may be void in BISSELL's sole discretion. It may be necessary to obtain some of your personal information, such as a mailing address, to fulfill the terms of this warranty. Any personal data will be handled pursuant to BISSELL's Privacy Policy, which can be found at global.BISSELL.com/privacy-policy.

Limited 2- or 6-Year Warranty (varies by model)

Model 3672E: Limited 2-Year Warranty

Model 3670E: Limited 6-Year Warranty

For two or three years from the date of purchase by the original purchaser, subject to the EXCEPTIONS AND EXCLUSIONS* identified below, BISSELL will repair or replace (with new, refurbished, lightly used, or remanufactured components or products), at BISSELL's option, free of charge, any defective or malfunctioning part or product.

BISSELL recommends that the original packaging and original proof of purchase with the date of purchase and country where purchased be kept for the duration of the warranty period in case you want to redeem the warranty during the warranty period. Keeping the original packaging will assist with any necessary re-packaging and transportation but is not a condition of the warranty.

If your product is replaced by BISSELL under this warranty, then the new item will benefit from the remainder of the term of this warranty (calculated from the date of the original purchase). The period of this warranty shall not be extended whether or not your product is repaired or replaced.

*Exceptions and Exclusions from the Terms of the Warranty

This warranty applies to products used for personal domestic use and not commercial or hire purposes. Consumable components and attachments such as filters, belts, shells, water tanks, scraping strips, brushes, and mop pads, which must be replaced or serviced by the user from time to time, are not covered by this warranty. This warranty does not apply to any defect arising from fair wear and tear, including but not limited to the battery discharging time shortening due to the aging or use. Damage or malfunction caused by the user or any third party whether as a result of accident, negligence, abuse, neglect, or any other use not in accordance with the user guide is not covered by this warranty. An unauthorised repair (or attempted repair) may void this warranty whether or not damage has been caused by that repair/attempt. Removing or tampering with the Product Rating Label on the product or rendering it illegible will void this warranty.

Except as set out below, BISSELL and its distributors are not liable for any loss or damage that is not foreseeable or for incidental or consequential damages of any nature associated with the use of this product including without limitation loss of profit, loss of business, business interruption, loss of opportunity, distress, inconvenience, or disappointment. Except as set out below, BISSELL's liability will not exceed the purchase price of the product.

BISSELL does not exclude or limit in any way its liability for (a) death or personal injury caused by our negligence or the negligence of our employees, agents or subcontractors; (b) fraud or fraudulent misrepresentation; (c) or for any other matter which cannot be excluded or limited under law.

Important Notes

- If your BISSELL product should require service or to claim under our limited warranty, please visit global.BISSELL.com.
- Please keep your original sales receipt. It provides proof of the date of purchase and where it was purchased in the event of a warranty claim. See warranty for details.
- Please note that using your BISSELL machine outside of its country of original purchase and/or use with a power converter may damage your BISSELL machine and damage caused by mismatched power voltage will not be covered by your warranty.
- Please note that putting vinegar, bleach, dish soap, detergent, homemade soap, and other non-BISSELL products in your BISSELL machine may damage your BISSELL machine. Damage caused by using non-BISSELL products in your machine will not be covered by your warranty.

ቅጽ 1 ላይ የተገለጹትን ስራዎች ለማጠናቀቅ ይጠቀሙ። ለመጨረሻ ስራዎች ለማጠናቀቅ ይጠቀሙ።

<p>ቅጽ 2 ላይ የተገለጹትን ስራዎች ለማጠናቀቅ ይጠቀሙ። ለመጨረሻ ስራዎች ለማጠናቀቅ ይጠቀሙ።</p>	<p>ቅጽ 3 ላይ የተገለጹትን ስራዎች ለማጠናቀቅ ይጠቀሙ። ለመጨረሻ ስራዎች ለማጠናቀቅ ይጠቀሙ።</p>

<p>ቅጽ 4 ላይ የተገለጹትን ስራዎች ለማጠናቀቅ ይጠቀሙ። ለመጨረሻ ስራዎች ለማጠናቀቅ ይጠቀሙ።</p>	<p>ቅጽ 5 ላይ የተገለጹትን ስራዎች ለማጠናቀቅ ይጠቀሙ። ለመጨረሻ ስራዎች ለማጠናቀቅ ይጠቀሙ።</p>	<p>ቅጽ 6 ላይ የተገለጹትን ስራዎች ለማጠናቀቅ ይጠቀሙ። ለመጨረሻ ስራዎች ለማጠናቀቅ ይጠቀሙ።</p>

ቅጽ 7 ላይ የተገለጹትን ስራዎች ለማጠናቀቅ ይጠቀሙ። ለመጨረሻ ስራዎች ለማጠናቀቅ ይጠቀሙ።

تصليح الترس

في حال إصابة الترس بالآثار الناتجة عن سوء الصيانة، يجب تنظيفه وشمعه بالشمع الخاص به. يرجى تجنب استخدام زيت السيارات.

global.BISSSELL.com
تصليح الترس
في حال إصابة الترس بالآثار الناتجة عن سوء الصيانة، يجب تنظيفه وشمعه بالشمع الخاص به. يرجى تجنب استخدام زيت السيارات.

التصليح والصيانة

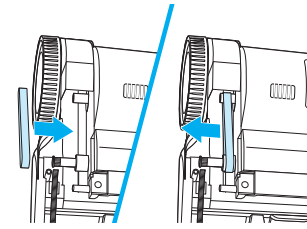
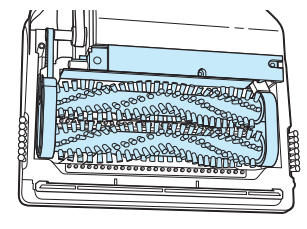
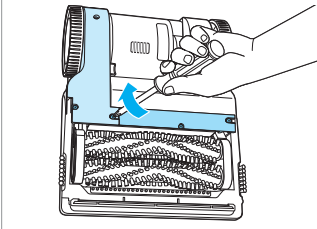
<p>1. تليق بالشمع</p> <p>تتمتع بشفط قوي ويحافظ على ساطعة لون الملابس وتحميها من التلف أثناء الغسيل.</p> 	<p>2. تنظيف الفرشاة</p> <p>يجب تنظيف الفرشاة بانتظام لإزالة الأوساخ المتراكمة. يمكن تنظيفها باستخدام فرشاة نظيفة مبللة.</p> 	<p>3. فحص الترس</p> <p>تأكد من أن الترس يعمل بشكل صحيح وأنه لا يوجد أي تلف أو تلف في الترس.</p> 
---	--	---

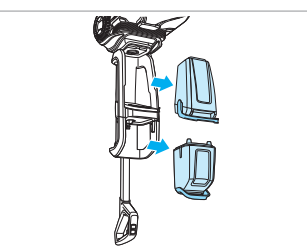
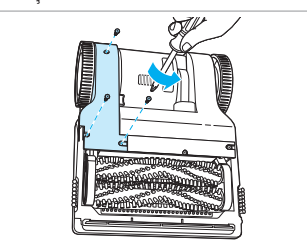
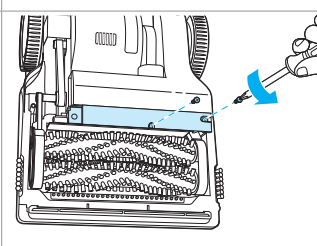
<p>4. فحص إبرة الخياطة</p> <p>تأكد من أن إبرة الخياطة مثبتة بشكل صحيح وأن إبرة الخياطة مناسبة لحجم الثقب في الملابس.</p> 	<p>5. تنظيف محرك الغسالة</p> <p>تأكد من أن محرك الغسالة نظيف وأنه لا يوجد أي انسداد في المحرك.</p> 	<p>6. فحص إبرة الخياطة</p> <p>تأكد من أن إبرة الخياطة مثبتة بشكل صحيح وأن إبرة الخياطة مناسبة لحجم الثقب في الملابس.</p> 
---	--	---

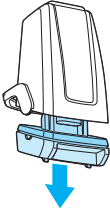
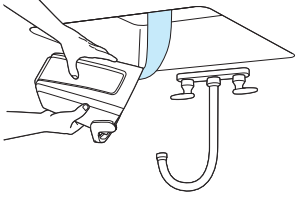
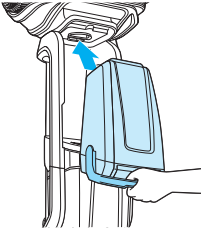
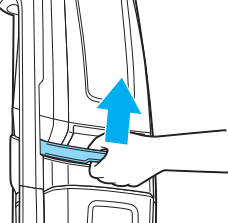
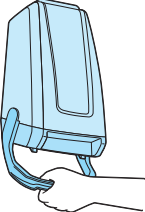
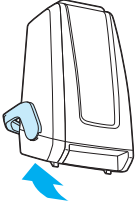
<p> 3. ታሽታ። ለግብርና ለመቆየት ለታሽታ። </p>	<p> ለግብርና ለመቆየት ለታሽታ። ለግብርና ለመቆየት ለታሽታ። </p>	<p> ለግብርና ለመቆየት ለታሽታ። ለግብርና ለመቆየት ለታሽታ። </p>
		
<p> 1. ግብርና ለመቆየት ለታሽታ። ለግብርና ለመቆየት ለታሽታ። </p>	<p> 1. ግብርና ለመቆየት ለታሽታ። ለግብርና ለመቆየት ለታሽታ። </p>	<p> 1. ግብርና ለመቆየት ለታሽታ። ለግብርና ለመቆየት ለታሽታ። </p>
		

ለግብርና ለመቆየት ለታሽታ። ለግብርና ለመቆየት ለታሽታ። ለግብርና ለመቆየት ለታሽታ።

ሆስፒታል ማጠገን ለማድረግ የሚያስፈልጉትን ስራዎች ያውቁ።

የሆስፒታል ማጠገን ለማድረግ የሚያስፈልጉትን ስራዎች ያውቁ። ለሆስፒታል ማጠገን የሚያስፈልጉትን ስራዎች ያውቁ።

ባለፈው ስራዎች ላይ ማጠገን

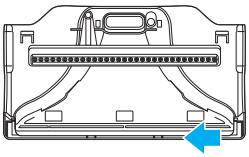
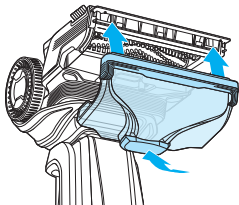
<p>የሆስፒታል ማጠገን ለማድረግ የሚያስፈልጉትን ስራዎች ያውቁ። ለሆስፒታል ማጠገን የሚያስፈልጉትን ስራዎች ያውቁ።</p>	<p>የሆስፒታል ማጠገን ለማድረግ የሚያስፈልጉትን ስራዎች ያውቁ። ለሆስፒታል ማጠገን የሚያስፈልጉትን ስራዎች ያውቁ።</p>
	

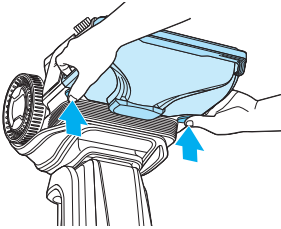
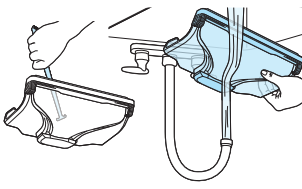
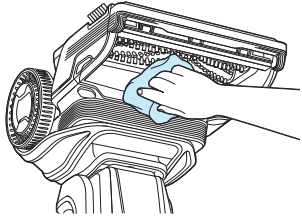
<p>የሆስፒታል ማጠገን ለማድረግ የሚያስፈልጉትን ስራዎች ያውቁ። ለሆስፒታል ማጠገን የሚያስፈልጉትን ስራዎች ያውቁ።</p>	<p>የሆስፒታል ማጠገን ለማድረግ የሚያስፈልጉትን ስራዎች ያውቁ። ለሆስፒታል ማጠገን የሚያስፈልጉትን ስራዎች ያውቁ።</p>	<p>የሆስፒታል ማጠገን ለማድረግ የሚያስፈልጉትን ስራዎች ያውቁ። ለሆስፒታል ማጠገን የሚያስፈልጉትን ስራዎች ያውቁ።</p>
		

የሆስፒታል ማጠገን ለማድረግ የሚያስፈልጉትን ስራዎች ያውቁ። ለሆስፒታል ማጠገን የሚያስፈልጉትን ስራዎች ያውቁ።

የሆስፒታል ማጠገን

የሆስፒታል ማጠገን (ባለፈው)

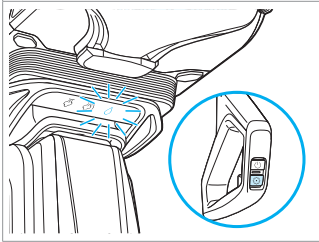
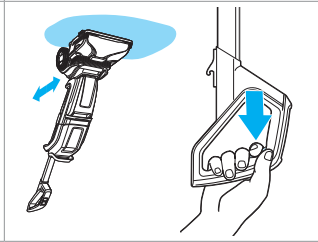
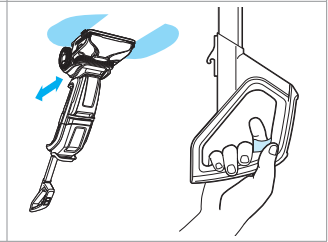
<p>1. اضغط على زر الوضع جيبى بضغطة زر (Quick Dry) وضع التجفيف السريع. الموجد في قاعدة الجهاز. الموجود في الوضع جيبى بضغطة زر.</p>	<p>2. اضغط على دواسمة الإزالة للخطأ للماء الجلب. اسحب الزناد لتوزيع الماء وسوائل التنظيف. ألقها في سلة المهملات. في وقت لاحق، اغسلها في الغسالة. اغسلها في وقت لاحق.</p>	<p>3. حر الزناد وقم بدمج الماء في حوض الاستحمام. الماء يصبغ الميزن على السخانة أو في حوض الاستحمام. في وقت لاحق، اغسلها في الغسالة. اغسلها في وقت لاحق.</p>
		

استخدم الماء وسوائل التنظيف للتجفيف السريع. سوف ينفذ السخانة في حوالي 30 دقيقة.

وسج التجفيف السريع (Quick Dry)

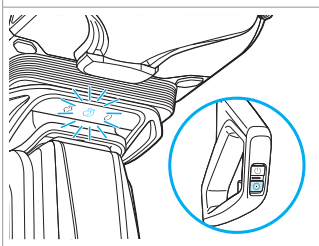
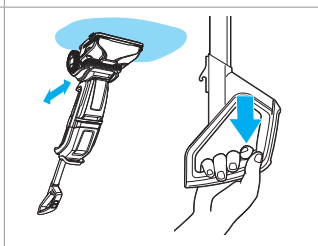
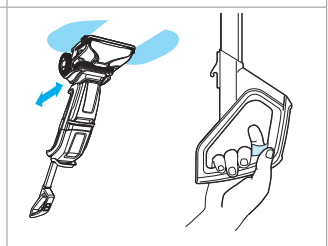
<p>1. اضغط على زر الوضع جيبى بضغطة زر (SteamWash) وضع التنظيف البخاري. الموجد في قاعدة الجهاز. الموجود في الوضع جيبى بضغطة زر. عند ضوء الموقد حثيثا: سيطر ضوء الموقد.</p>	<p>2. اضغط على دواسمة الإزالة للخطأ للماء الجلب. اسحب الزناد لتوزيع الماء وسوائل التنظيف. ألقها في سلة المهملات. في وقت لاحق، اغسلها في الغسالة. اغسلها في وقت لاحق.</p>	<p>3. حر الزناد وقم بدمج الماء في حوض الاستحمام. الماء يصبغ الميزن على السخانة أو في حوض الاستحمام. في وقت لاحق، اغسلها في الغسالة. اغسلها في وقت لاحق.</p>
		

وسج التنظيف البخاري (SteamWash™ Max Clean)

<p> 1. </p>	<p>2. </p>	<p> </p>

1. ||

<p> </p>	<p> </p>

||

<p> </p>	<p> </p>

||

||

||

||



تعليمات تنظيف بيشل للقطران

تعليمات تنظيف بيشل للقطران باستخدام المحلول الطبيعي و Natural Carpet Deep Cleaning Solution و Wash & Protect Pet Stain & Odour و Wash & Protect Pro Stain & Odour و Oxy Boost و Pet Stain Pre-treat و Stain Pre-treat و Wash & Protect Stain & Odour و Wash & Protect Pro Stain & Odour. الطراز: 3672E الطراز: 3670E الطراز: 3672E Wash & Protect Pro Stain & Odour.

<p>1. ملء خزان المياه بالماء البارد. تجنب ملء الخزان بالماء الساخن أو الماء المغلي. (الحد الأقصى لدرجة حرارة الماء 140 درجة فهرنهايت) 2. أضف كمية كافية من الماء الصابوني الدافئ. 3. امسك بغطاء الخزان.</p>	<p>4. اضغط على زر التشغيل. ستنشغل المضخة. 5. امسك بغطاء الخزان.</p>	<p>6. اضغط على زر التشغيل. ستنشغل المضخة. 7. امسك بغطاء الخزان.</p>



<p>8. امسك بغطاء الخزان. 9. امسك بغطاء الخزان. 10. امسك بغطاء الخزان.</p>	<p>11. امسك بغطاء الخزان. 12. امسك بغطاء الخزان.</p>	<p>13. امسك بغطاء الخزان. 14. امسك بغطاء الخزان.</p>



1. تجنب ملء الخزان بالماء الساخن أو الماء المغلي. (الحد الأقصى لدرجة حرارة الماء 140 درجة فهرنهايت) 2. أضف كمية كافية من الماء الصابوني الدافئ. 3. امسك بغطاء الخزان.

4. اضغط على زر التشغيل. ستنشغل المضخة. 5. امسك بغطاء الخزان.

6. اضغط على زر التشغيل. ستنشغل المضخة. 7. امسك بغطاء الخزان.

تعليمات تنظيف بيشل للقطران باستخدام المحلول الطبيعي و Natural Carpet Deep Cleaning Solution و Wash & Protect Pet Stain & Odour و Wash & Protect Pro Stain & Odour و Oxy Boost و Pet Stain Pre-treat و Stain Pre-treat و Wash & Protect Stain & Odour و Wash & Protect Pro Stain & Odour. الطراز: 3672E الطراز: 3670E الطراز: 3672E Wash & Protect Pro Stain & Odour.

-  **وضع التجفيف السريع (Quick Dry)** سوف يستخدم الماء وسوائل التنظيف للتطبيق السريع. سوف يجف السجاد في حوالي 30 دقيقة.
-  **وضع التنظيف العميق (SteamWash™ Max Clean)** يستخدم الماء وسوائل التنظيف والبخار لتنظيف سجادك.
-  **وضع المعالجة المسبقة للبخار (Steam Pretreat)** يهدف إلى إزالة البقع الصعبة قبل إزالتها باستخدام وضع التنظيف العميق (SteamWash Max Clean).
وضع المعالجة المسبقة للمعالجة المنبثقة (Steam Pretreat) يهدف إلى إزالة البقع الصعبة قبل إزالتها باستخدام وضع التنظيف العميق (SteamWash Max Clean).





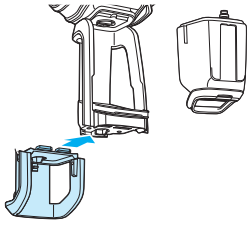
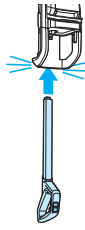
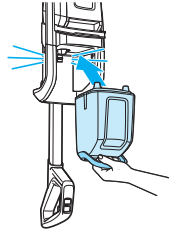

-  **التشغيل** تأكد من إبقاء الجهاز وإيقافه.
-  **الوضع** في التبديل بين أوضاع المعالجة المسبقة (Steam Pretreat)، والتنظيف العميق (SteamWash Max Clean)، والتجفيف السريع (Quick Dry). يظهر الشاشة الموجودة في الجهاز والوضع على الشاشة الموجودة في الجهاز.

الشاشة الموجودة في الجهاز وأوضاع التنظيف

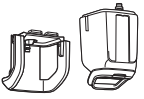
أدوات التنظيف وأوضاع التشغيل

<p>1. قم بإزالة أجزاء البطانة من الجهاز في الجزء السفلي من الجهاز. وتأكد من أن الجزء السفلي من الجهاز مستوي مع الجزء السفلي من الجزء السفلي من الجهاز. تأكد من أن الجزء السفلي من الجهاز مستوي مع الجزء السفلي من الجهاز. تأكد من أن الجزء السفلي من الجهاز مستوي مع الجزء السفلي من الجهاز.</p>	<p>2. أدخل المفضي في الجهاز في مكانه. قم بإدخال المفضي في الجهاز في مكانه.</p>	<p>3. أدخل الجزء المنزلق للبطانة في الجهاز. قم بإدخال الجزء المنزلق للبطانة في الجهاز.</p>
		

ملاحظة: يرجى الرجوع إلى دليل المستخدم للحصول على مزيد من المعلومات. global.BISSSELL.com للتعليمات. 

الجزء المنزلق للبطانة والجزء السفلي من الجهاز	أجزاء السفلى التي تحتاج إلى المعالجة المسبقة	مفضي	حديقة العروة و أدوات التنظيف	الأدوات (تختلف حسب الطرق)	السوائل
					

تعليمات: يرجى الرجوع إلى دليل المستخدم للحصول على مزيد من المعلومات. global.BISSSELL.com للتعليمات. **تنبيه:** يرجى الرجوع إلى دليل المستخدم للحصول على مزيد من المعلومات.

نظرة عامة على المبيد

١. التعامل مع أدوات التنظيف
٢. مقياس جرعات المبيد
٣. جرعات المبيد المخصصة
٤. مقياس جرعات المبيد المستخدمة
٥. مقياس الجرعات
٦. جرعات المبيد المستخدمة
٧. الصواعق موفرة الطاقة
٨. بطاريات جراب المبيد
٩. HydroSteam™ بتريم
١٠. فرش Edgesweep™
١١. ربط أطراف الخار والسوائل
١٢. أداة لفتح Quick Release™
١٣. دواسه الأجزاء الخلفية

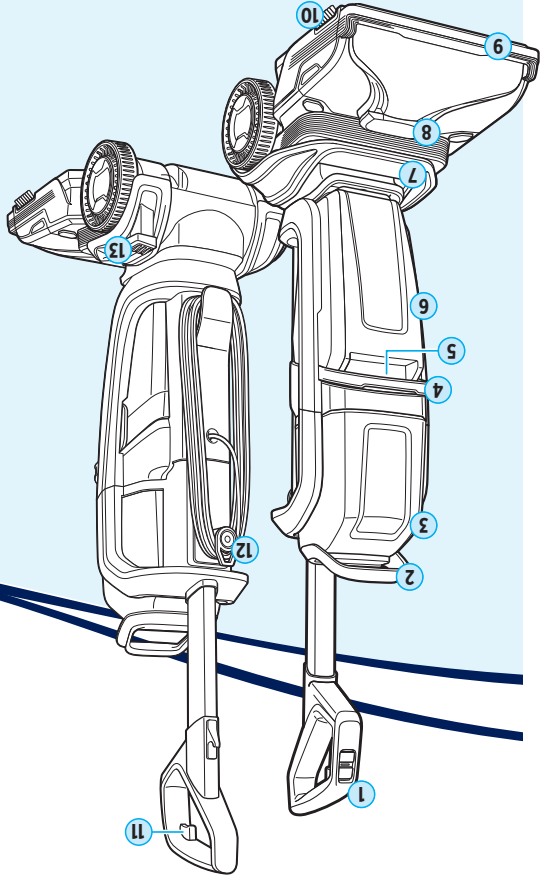

- ٠ ٠
- ٣ ٣
- ٣ ٣
- ٣ ٣
- ٣ ٣

- ١٢ ١٢
- ١١ ١١
- ١١ ١١
- ٧ ٧
- ٧ ٧

البرازيل 3670E و 3672E

REVOLUTION™ HYDROSTEAM™

Bissell®

